

Intraoral Image Sensor

RXS 1000

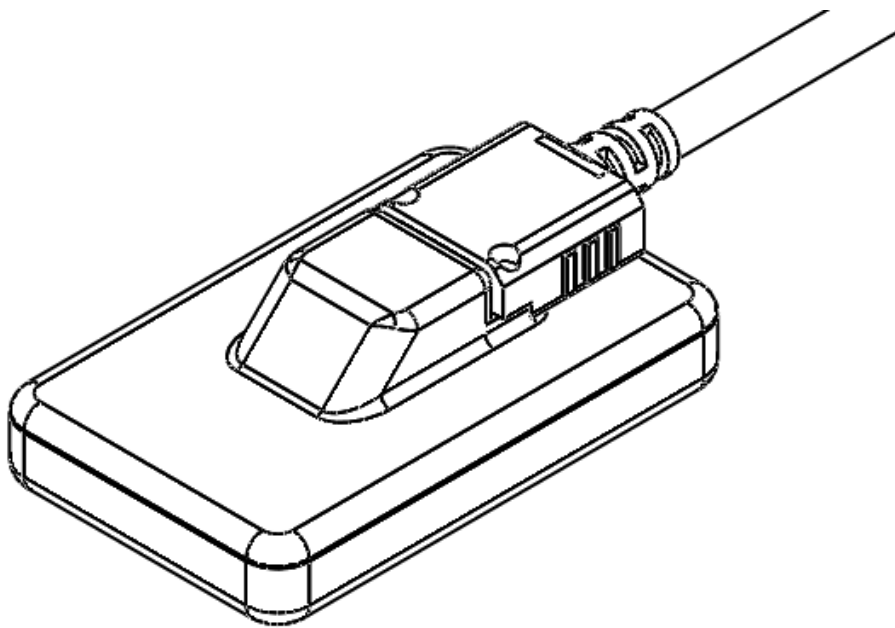

USER'S MANUAL

Rolence Enterprise, Inc.

No.18-3, Lane 231, Pu Chung Rd., Chungli, Taoyuan 32083, Taiwan
TEL: +886-3 463-1999; FAX: +886-3 463-1997

Authorized dealer dealer in Vietnam market:

Viet Nha Co., Ltd.

Add: 31 street #5, Binh Trung Tay ward, Thu Duc city, Ho Chi Minh city, VN.

Showroom: 008E Tan Da street, ward 11, district 5, Ho Chi Minh city, Vietnam

Email: Sales@vietnha.com

Website: www.vietnha.com

Tel: 028.666.04836

Mobile: 0906.828.139

The manual described herein shall be incorporated for intent of using RXS1000 and accompanying software therefore must be studied prior to use of the product.

User manual distributed in conjunction with the product may be changed without prior notice depending on quality upgrades and specification changes.

For inquiries concerning the product and its manual, contact the Rolence Enterprise, Inc. customer service center.

Table of Contents

1	Introduction...3
2	Symbols...3
3	Content...4
4	Precautions for use...4
5	Computer Operating Environment...5
6	Software...6
7	Capturing Intraoral Images...13
8	Hygiene and Maintenance...15
9	Exposure Values Table...16
10	Technical Specifications...17

1. Introduction

The RXS1000 is intended to acquire real-time, clinical digital intraoral X-ray images using a solid-state imaging sensor. This system consists of the CMOS sensor and software for image display. This system senses the onset of the X-ray exposure and automatically acquires and save the image data to a PC(software).

1.1 Feature

- USB 3.0 Interface
- Pixel size: 20 x 20 μm
- Image size: 30 x 20 mm
- Resolution: 1500 x 1000 pixels

1.2 Intended Use

This system is intended to collect dental x-ray photons and convert them into electronic impulses that may be stored, views and manipulated for diagnostic use by dentists.

1.3 Contact duration of applied part

- Sensor (Contact Duration: Less than 1 min)

1.4 Contact area of applied part

- Sensor Contact area: Less than 42mm X 26.2mm (Size1)
(The cable can be considered to be an accessible part)

2. Symbols

Among all symbols used in this system, the symbols in table are indicative of symbols closely related to patient and user safety.



Date of manufacture



Manufacturer



This symbol means general warning sing



To indicate compliance of guidelines appearing in the manual for safe operation of the equipment.



Type BF equipment

3. Content

1. RXS1000 intraoral image sensor.
2. CD containing image software and RXS1000 usb driver.
3. Disposal sleeves x 50pcs.

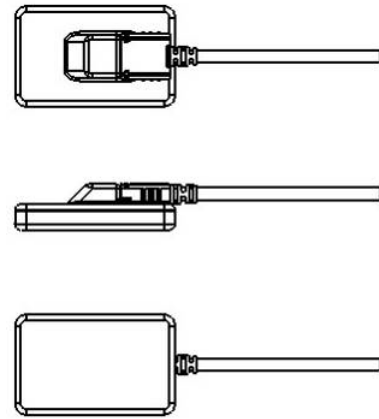

4. Precautions for use

- The system should be operated by qualified personnel only
- Learn how to use the product properly before using
- Check whether the product operates normally before it is used. Do not use the product if abnormality is found at that time or during use
- Do not use the product in places where chemicals are stored or where there is generation of gas.
- Do not twist, bend, pull and pinch the Cable strongly. These actions might cause damage to the Cable.
- Check that the USB connector is not wet and dirty before the USB connector is plugged.
- Do not expose the Cable to any source of humidity such as damp cloth or spray because the Cable is deteriorated by humidity
- Do not apply any pressure to the sensor unit.
- If the product is used in a temperature of 22°C for a long time, the maximum temperature of the sensor unit will be 40°C. Use the product with paying attention to the temperature of sensor unit.
- Do not exceed 1 minute for skin contact duration with sensor unit.
- Do not unplug the USB connector while the product is being used.
- The sensor unit might be damaged due to Static electricity. Do not touch pins of the USB connector.
- If you use the product beyond the durable period, check the performance of the product carefully before using.
- Use hygienic protective sheath that is enough to cover sensor and cable longer than 10cm to prevent infection. Sensor sheet should be single use only and purchased by User.

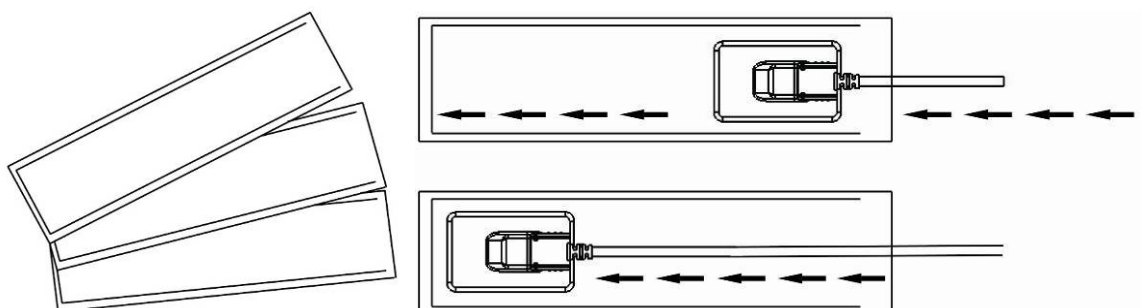

- Use of wireless mobile phones and similar wireless devices in the vicinity of this system is prohibited. Use of devices compliant with EMC standards in close proximity can lead to unintended activities due to electromagnetic interference.
- No modification of this equipment is allowed.
- A warning against servicing and maintenance while the equipment is in use.



Since the system includes industrial waste materials in the composition, an inappropriate disposal of materials can cause environmental pollution. Therefore, do not dispose of the waste along with common industrial or household waste. When disposing of the system in whole or in parts, comply with the related regulations of the standing legislation. For waste disposal related matters, consult with Rolence Enterprise Inc. or authorized agent in each region.

5. Computer Operating Environment

CPU	Intel i3 or higher
RAM	2GB or more
HDD space	200GB or more
Resolution	1024 x 768 or higher
Video	Video Card with over 128MB RAM
USB port	USB 2.0 & 3.0 supported
CD-ROM	24X or higher
Operating System	Windows XP (32bit or 64bit) Windows XP Professional (32bit or 64bit) Windows 7, 8, 10 (32bit or 64bit) Windows 7, 8, 10 Professional (32bit or 64bit) Or higher



As the intra-oral sensor is situated inside the patient environment (less than 1,5m / 4.9ft from the patient), your computer must necessarily comply with standard EN/IEC60601-1, or your installation including the computer must have been rendered compliant with standard EN/IEC60601-1-1. You can connect the sensor to your computer without additional precautions once your complete installation is compliant with standard EN/IEC60601-1. If the computer is not situated in the patient environment and is not compliant with standard EN/IEC60601-1, it is necessary to place the sensor in non-conductive packaging.

6. Software

The RolenceXraySensor 1000 software is able to acquire the image through RXS1000 and save the image to PC immediately.

Installation of USB Driver

1. Please install the driver under Win7 or Win10. Choose "Manage" after right click on my computer.

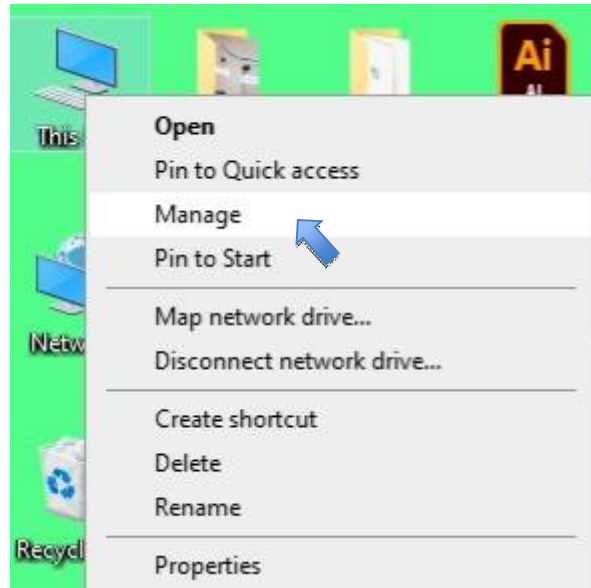

2. Device Manage --> WestBridge --> Update Driver

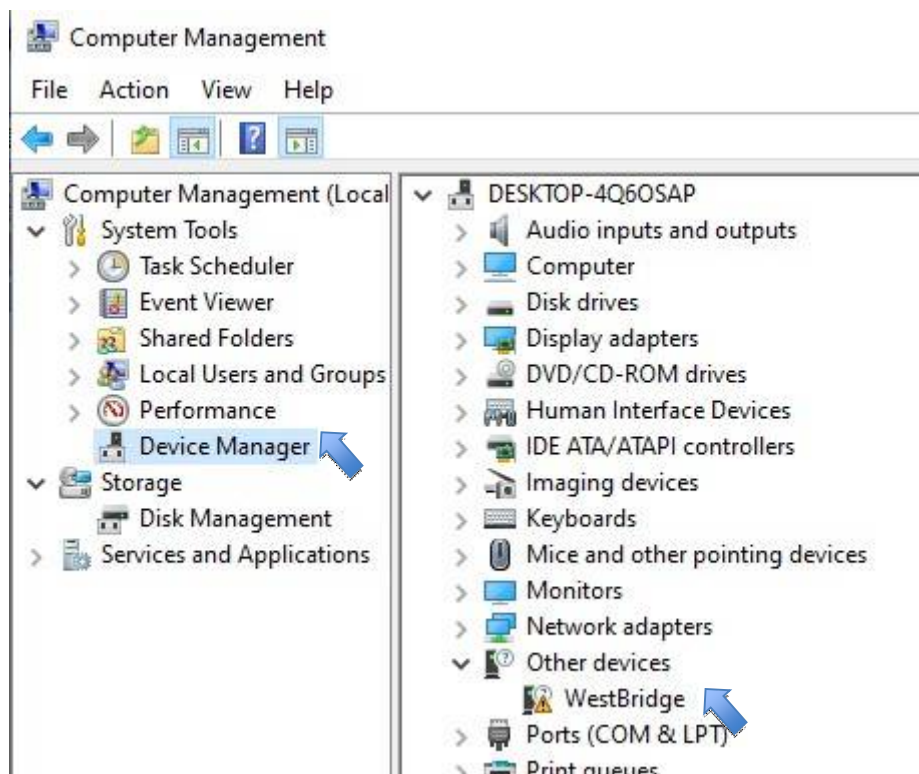

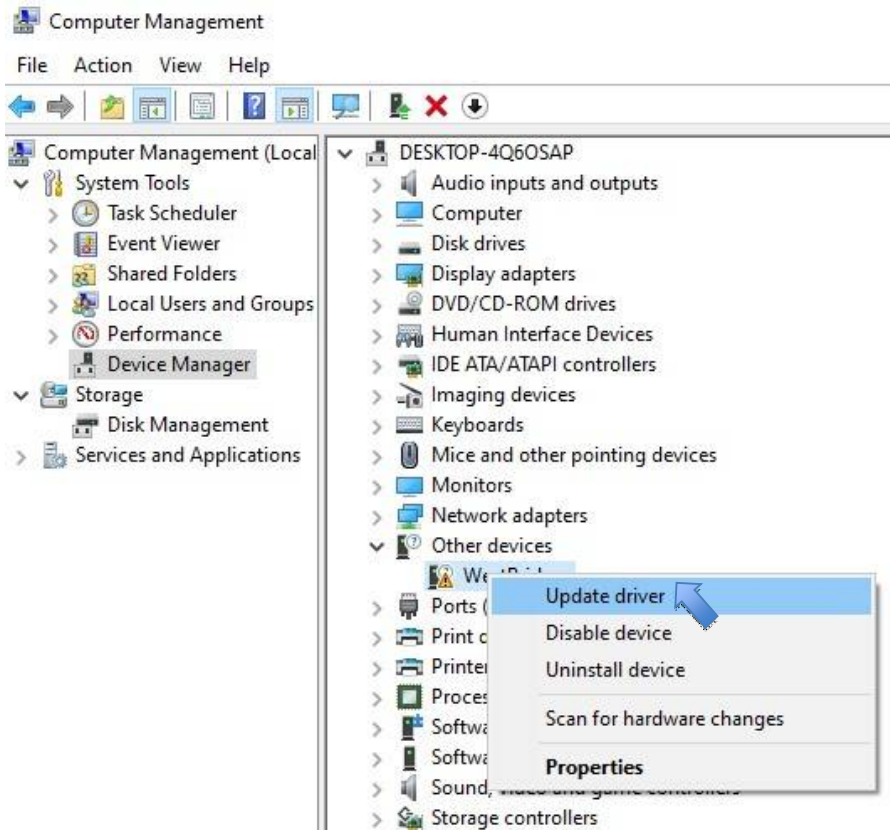

3. Click on 「Browse my computer for driver software Locate and install driver software manually」

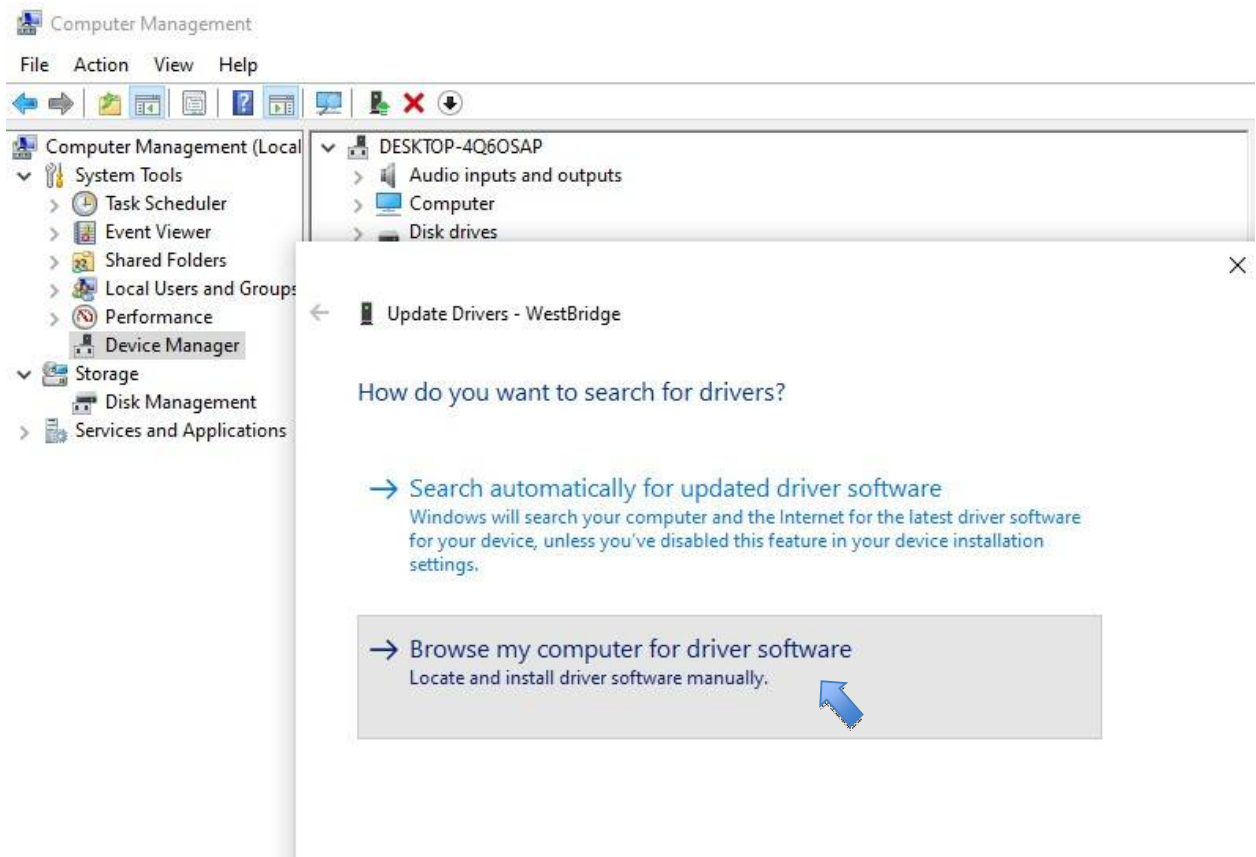

4. Choose disk for saving the driver

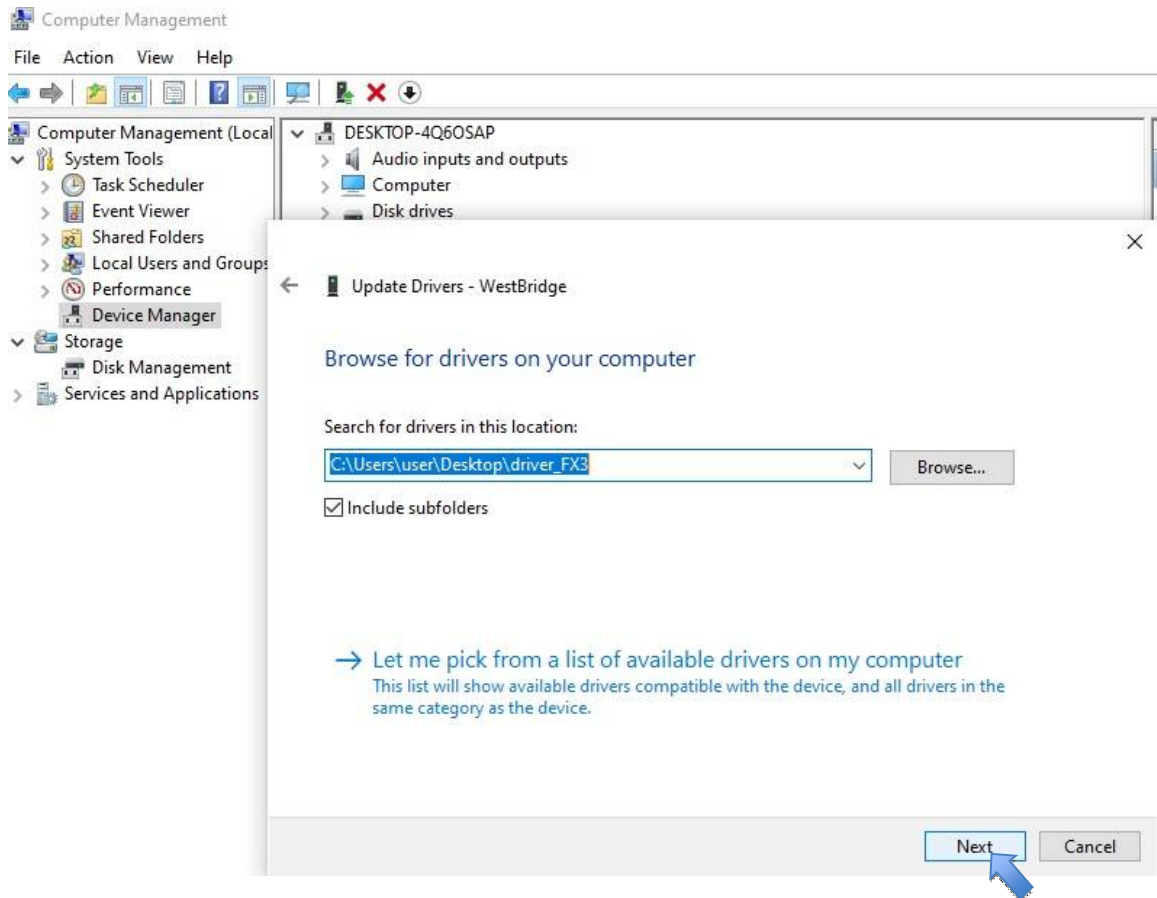

5. Click Win7 under Driver_FX3 and press OK bottom

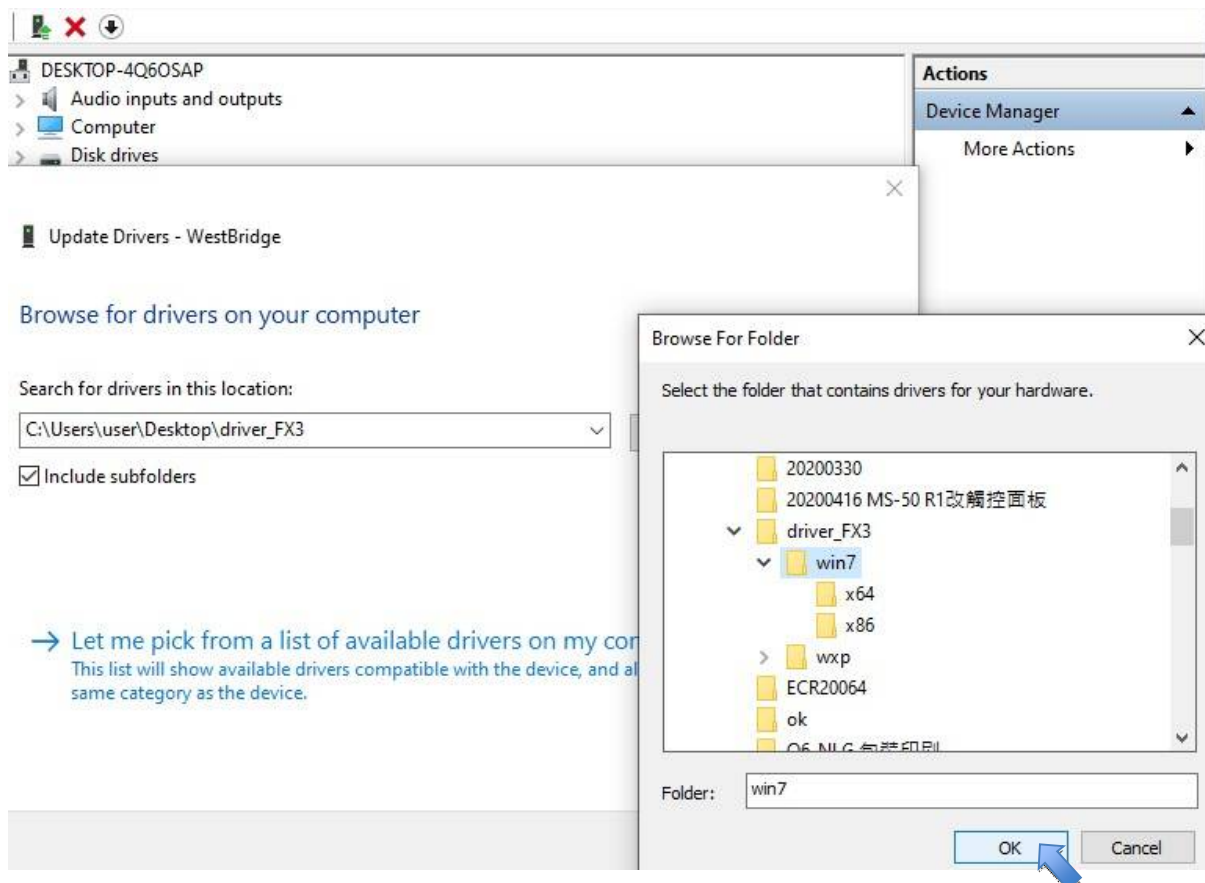

6. Click next once confirmed the installation root.

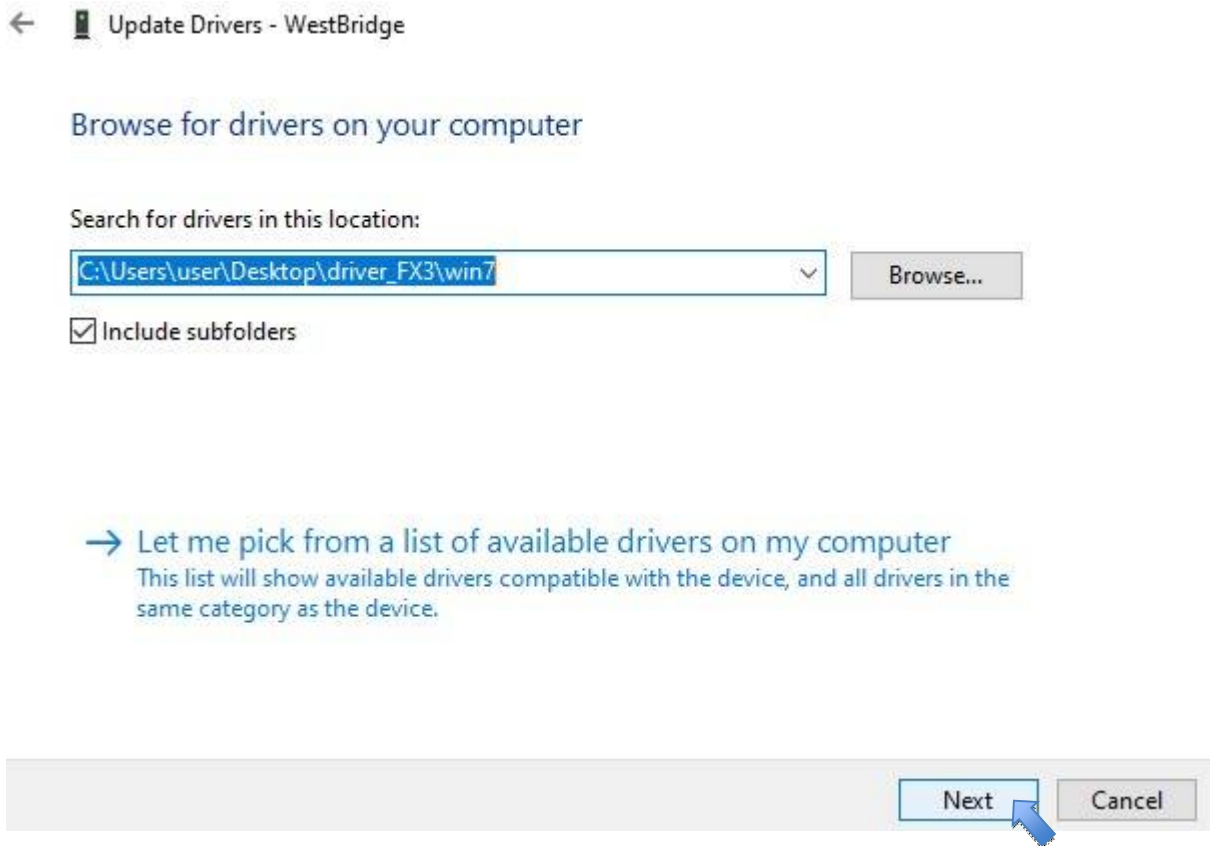

7. Click Close after installation completed.

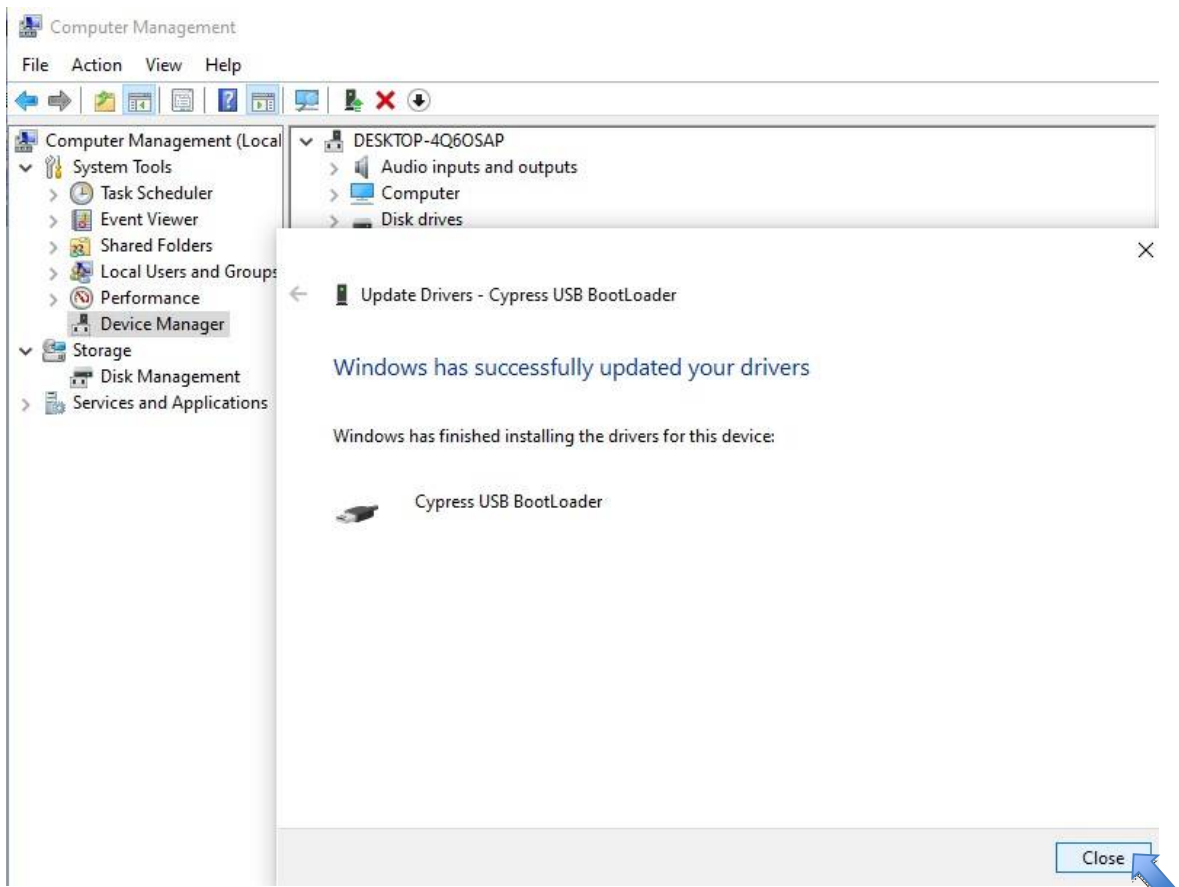

8. You'll find Cypress USB BootLoader after install the driver



RXS-1000.exe start up and configuration

1. Click the ICON on the desktop to start RXS 1000.



2. Welcome page, may takes few second before entering main screen



3. Key in Patient ID before operating, we key in "Ben" for testing.



4. Main Screen after key in ID

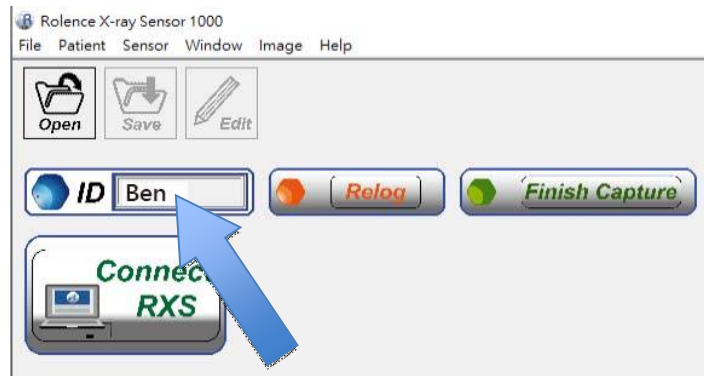

5. Connect the sensor to the PC/Laptop, and click connect RXS.

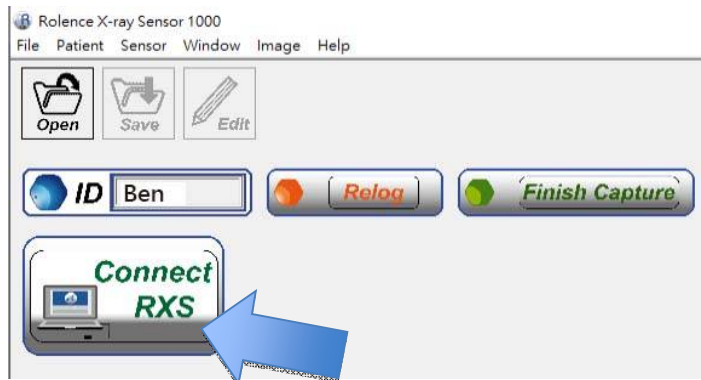

6. Make sure the Sensor connect the to PC/Laptop properly and click "Connect"

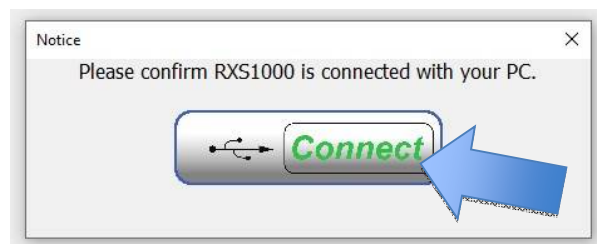

7. Reminder window to remind user that Sensor is well connected.

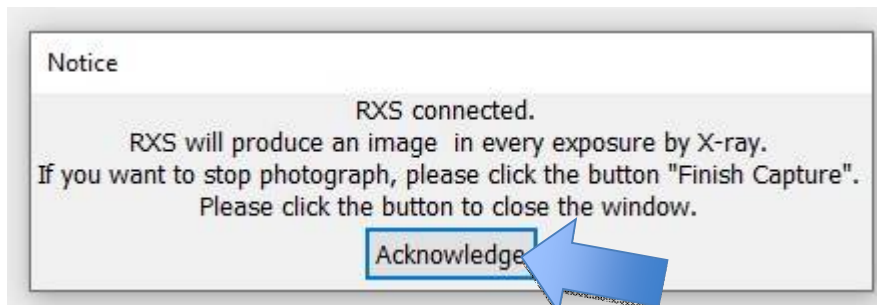

8. Sensor connected and able to capture at anytime.



9. Click Finish Capture after capture for patient "Ben" has been done.

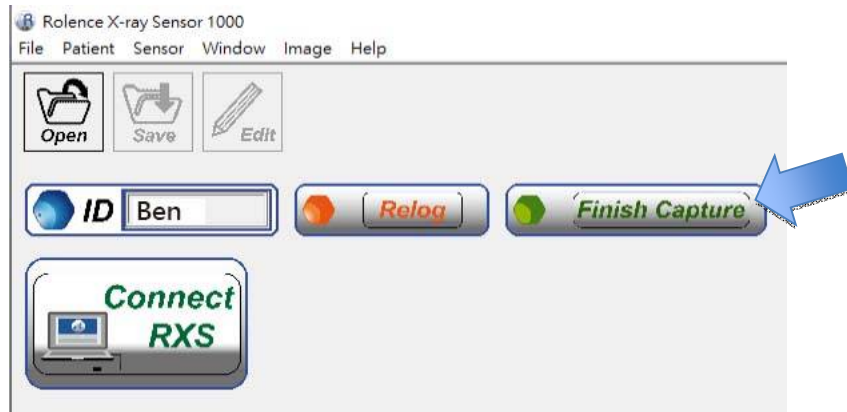

Please remove the RXS-1000 and reconnect again for a new capture.

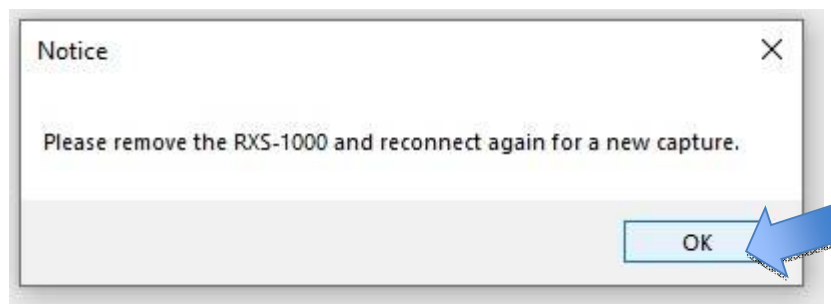

10. Click Open for edit what we captured for Ben

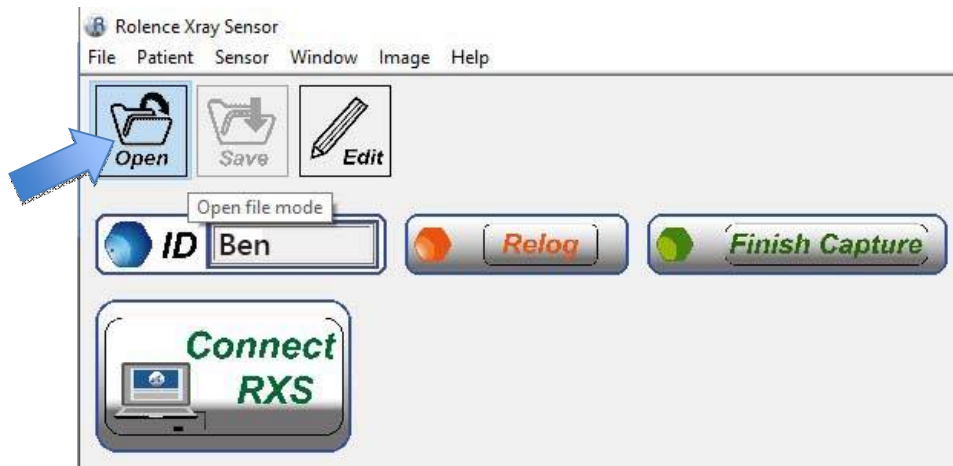

11. Bottom of the main screen will show all photos under Ben



12. Click Edit to start edit function, you're able to "Rotate", "Negative", adjust the "Contract" and "Brightness" at this interface, click undo if you're not going to save any amended.

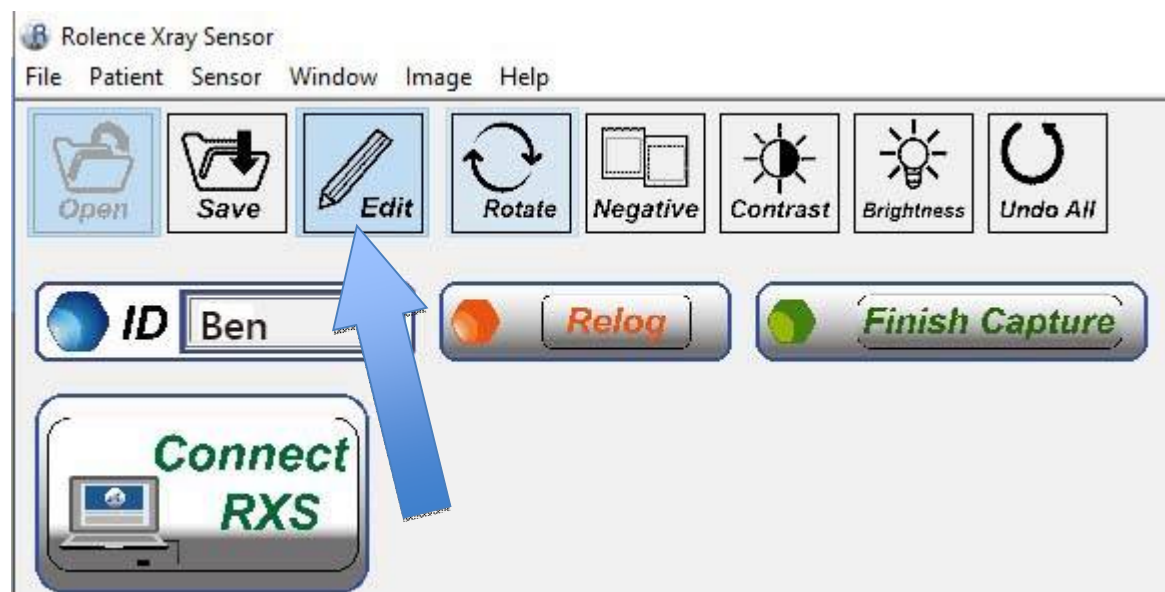

13. Use the bar of right side to adjust the "Contrast" and "Brightness"

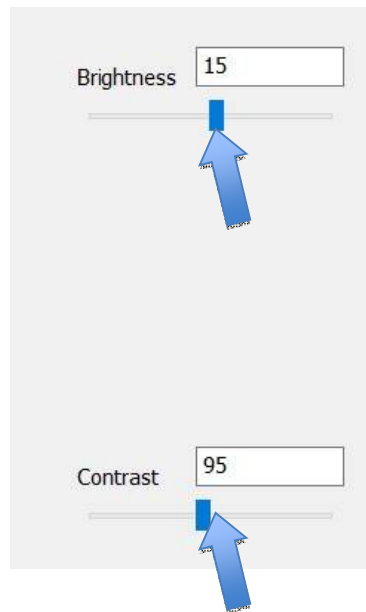

14. You can click "Edit" or "Save" to choose whether save the files or not editing.

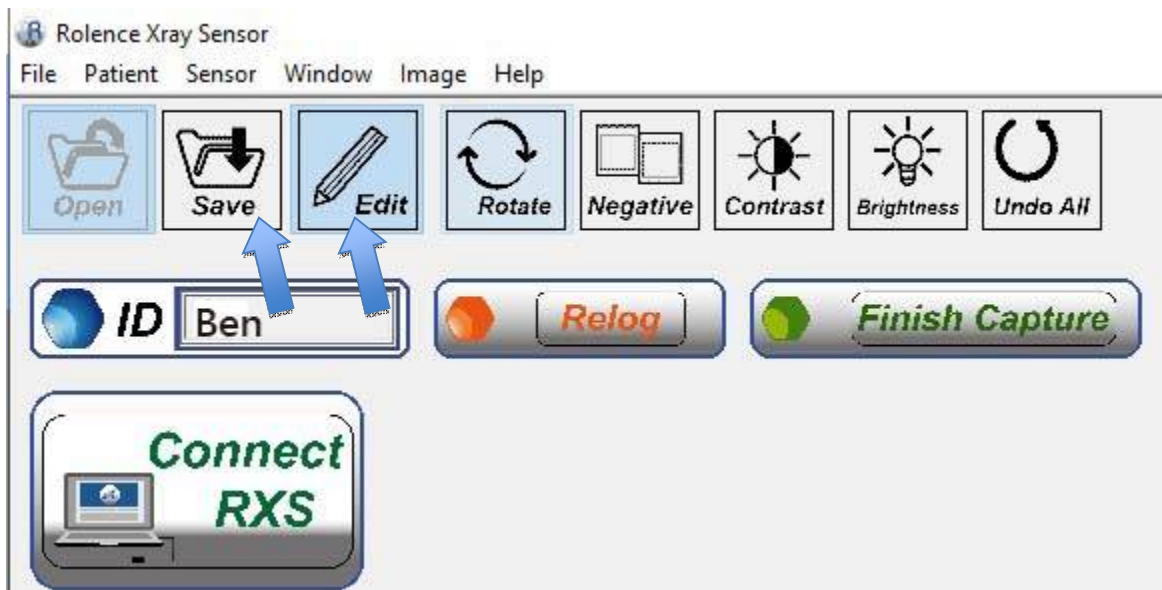

15. Well Saved.

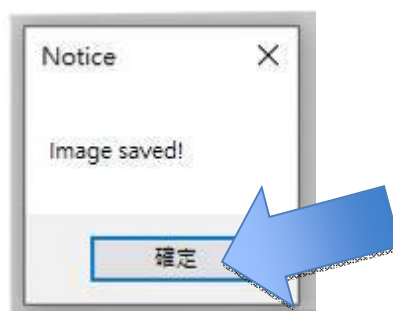

7. Capturing Intraoral Images

1. Before being able to acquire an image with the sensor, you need to start the computer to which it is connected and start the imaging software.
2. Set to proper parameters (exposure time, etc.) on the X-ray generator.
3. Cover the sensor with a hygienic protective sheath making sure to cover a sufficient length (at least 10cm) of cable.

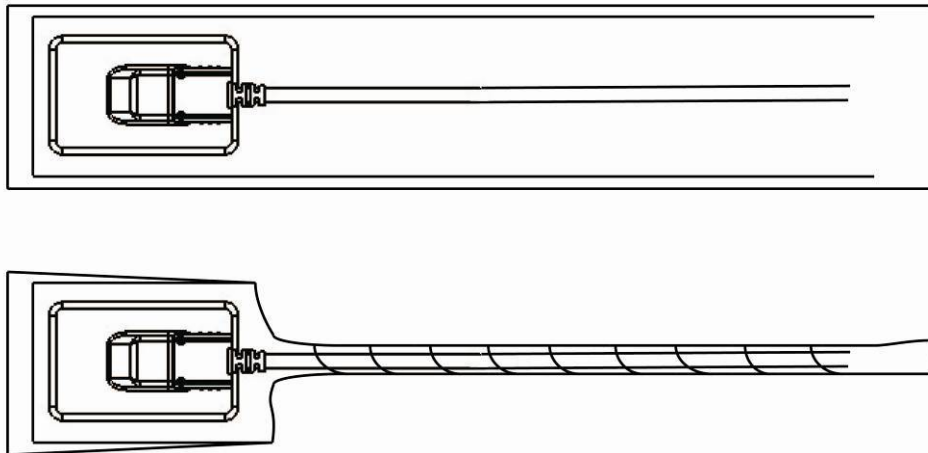

4. Ensure the sensor is positioned perpendicularly to the X-ray beam.

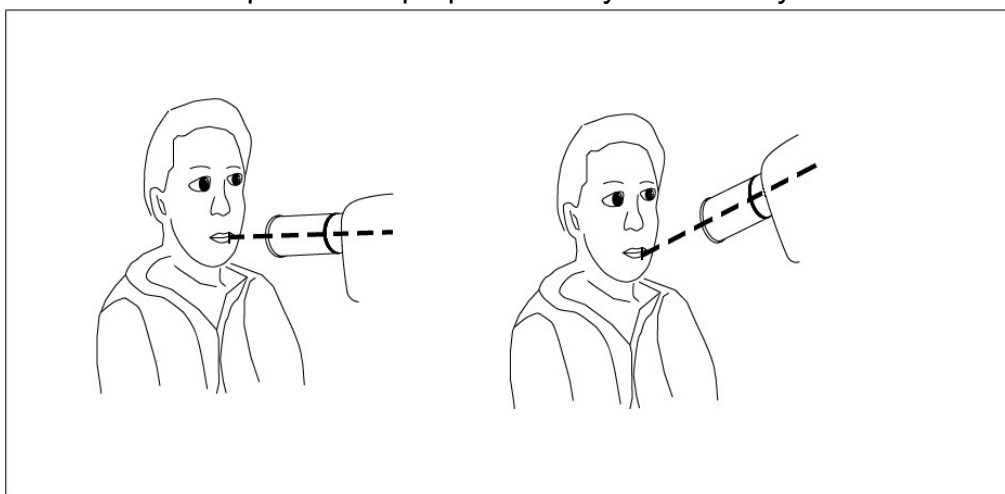

Correct

Error

The X-ray direction should be aligned with the sensitive area of the sensor, and the angle should be orthogonal.

5. When the sensor is placed in the mouth it is necessary to check that the sensitive area is turned towards the radiation source and that the whole sensitive area is irradiated.

6. Activate the generator. Once the image acquired, it appears in the imaging software, afterward a new acquisition is available.

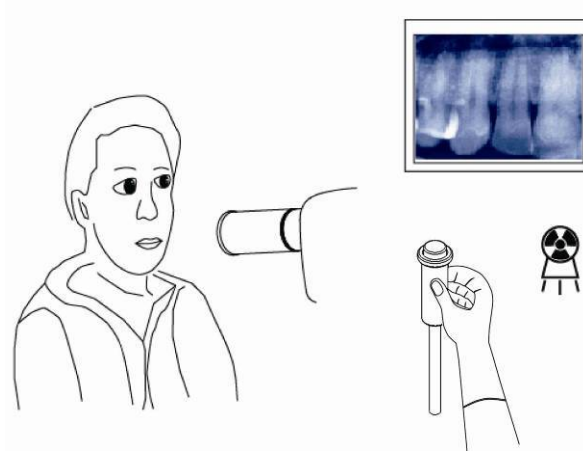

To avoid cross-contamination between patients during use, it is necessary to protect the sensor with hygienic single-use protective sheaths.



The kit must be handled with care, minimize the twisting, pulling and bending of the attachment cable. Do not step or roll on the cable. Do not pull on the cable itself but on the connection plug to disconnect the USB cable.



Make sure the sensitive surface (the flat surface) of the sensor is directed towards the X-ray generator. The back of the sensor (rounded) does not react to X-rays and does not produce an image on-screen.



Even though the sensor is resistant to impacts, it is strongly recommended to not let it fall on the floor. If a physical impact should exceptionally happen, contact your distributor and do not try to intervene yourself.

8. Hygiene and Maintenance

- To avoid cross-contamination between patients during use, it is necessary to protect the sensor with hygienic single-use protective sheaths.
- Do not pull on the cable when removing the used protective sheath.
- The cable can be cleaned with caution by using a disinfecting wipe. Hold the sensor with one hand and, with the other hand, apply a disinfecting wipe from the side of the sensor along the first 20cm / 8inch of the cable without pulling on the cable; subsequently clean the remainder of the cable in segments of 20-30cm / 8-12inch with as little pinching of the cable as possible, the wipe should slide without applying force.
- Do not immerse the sensor unit in disinfectants or any other chemicals.
- Wipe the sensor unit and the Cable near the sensor unit with some cloth with 70% isopropyl alcohol to disinfect it.
- Excessive wiping may result in damage to the sensor unit or the Cable.
- Do not apply any liquid or disinfectant to the product except 70% isopropyl alcohol.
- Do not sterilize the product by heating, autoclaves or UV.
- While the product is not used, putting it into packing box we sent is recommended to avoid the damage of static electricity.
- Store the product in places where there are no adverse effects due to pressure, heat, humidity, ventilation, direct sunlight, dust, chloride or sulfide.
- Do not store in places where chemicals are stored or where there is generation of gas.
- Do not keep anything on the Cable or the sensor unit.

9. Exposure Values Table & Setting Reference

	Protocol	Patient	Exposure time
Maxilla	Incisor	Adult	0.2 sec
		Child	0.14 sec
	Premolar and Canine	Adult	0.3 sec
		Child	0.1 sec
	Molar	Adult	0.4 sec
		Child	0.2 sec
Mandible	Incisor	Adult	0.14 sec
		Child	0.08 sec
	Premolar and Canine	Adult	0.2 sec
		Child	0.14 sec
	Molar	Adult	0.3 sec
		Child	0.16 sec

- Exposure values for RXS 1000 with 20 cm (8") cones at 60kv/2ma
- The value varies with different X-ray generator.
- In order to improve the image quality, user can adjust the exposure time.

The RXS-1000 is designed for multiple dose settings, allowing the dose to be adjusted to suit specific diagnostic tasks. As a general recommendation, first use the dose and exposure time settings recommended by the X-ray machine manufacturer.

The RXS-1000 can be used at lower dose settings.

At low dose settings, it usually causes the image to appear grainy. If the image output of the RXS-1000 appears grainy, increase the dose setting.

If you get good results at a specific dose setting, you can maintain this setting to see if the user is still getting good results.

The RXS-1000 can be used at higher dose/exposure time settings.

At high dose/exposure time settings, it may result in inability to distinguish between air and soft tissue. Overexposure may occur in these areas. If the air and soft tissue areas in the image are overexposed, reduce the dose setting.

10. Technical Specifications

Sensor type CMOS

Scintillator CsI with optic fiber plate

Sensor dimension

Size 1 Outside: 42 x 26.2 x 6.7 mm (not including cable connection)

Image area: 30 x 20 mm

CMOS Pixel size: 20 x 20 μ m

CMOS Resolution: 1500 x 1000 pixels

Weight: 60 g

Connection: USB 3.0

Cable length: 3m

Environment

Operation environment

Temperature: 0 ~ 35°C

Humidity: 30 ~ 70 %

Atmospheric pressure: 800hPa ~1060hPa (Max. Height:2000 m)

Storage condition

Temperature: -20 ~ 70°C

Humidity: 10 ~ 70 %

Atmospheric pressure: 800hPa ~1060hPa

Transportation situation

Temperature: -20 ~ 70°C

Humidity: 10 ~ 70 %

Atmospheric pressure: 800hPa ~1060hPa

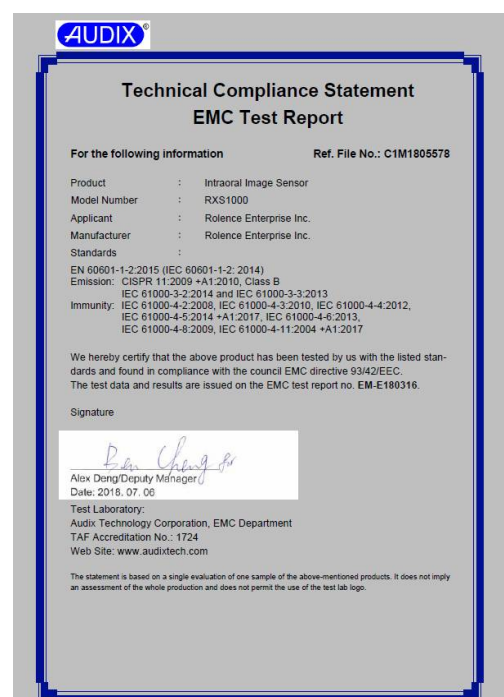

Test Report

Applicant : Rolence Enterprise Inc.
Manufacturer : Rolence Enterprise Inc.
EUT Description
(1) Product : Intraoral Image Sensor
(2) Model Number : RXS1000
(3) Power Rating : DC 5V
(4) Test Voltage : AC 230V, 50Hz (Via Notebook PC)

Applicable Standards:

EN 60601-1-2:2015 (IEC 60601-1-2: 2014)

Emission: CISPR 11:2009 +A1:2010, Class B

IEC 61000-3-2:2014 and IEC 61000-3-3:2013

Immunity: IEC 61000-4-2:2008, IEC 61000-4-3:2010, IEC 61000-4-4:2012,

IEC 61000-4-5:2014 +A1:2017, IEC 61000-4-6:2013, IEC 61000-4-8:2009,

IEC 61000-4-11:2004 +A1:2017

The device described above was tested by Audix Technology Corporation to determine the maximum emission levels emanating from the device, its ensured severity levels, and performance criterion. All of the tests were requested by the applicant and the results thereof based upon the information that the applicant provided to us. We, Audix Technology Corporation assumes full responsibility for the accuracy and completeness of these measurements. Also, this report shows that the EUT is technically compliance with the requirements of **EN 60601-1-2 standards**.

This report applies to above tested sample only and shall not be reproduced in part without written approval of Audix Technology Corporation.

Date of Report: 2018. 07. 06

Reviewed by:



(Kitty Ni/Administrator)

Approved by:

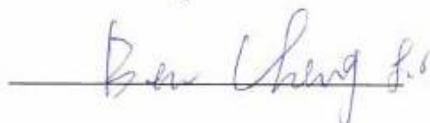

(Alex Deng/Deputy Manager)



Rolence Intraoral Image Sensor RXS1000 is
complied with European Medical Device Directive
93/42/EEC as amended by 2007/47/EC as Class IIa
device.

XXXX



EC Representative
MT Promedt Consulting GmbH
Altenhofstr. 80
66386 St. Ingbert, Germany
Phone: +49 6894 581020
Fax: +49 6894 581021
Email: info@mt-procons.com



No.18-3, Lane 231, Pu Chung Rd.,
Chungli, Taoyuan 32083, Taiwan
Phone: +886 3 4631999 FAX: +886 3 4631997

Authorized dealer dealer in Vietnam market:

Viet Nha Trading and Services Company Limited

Add: 170 Nguyen Duy Trinh Street, Binh Trung Tay ward, district 2,
Ho Chi Minh city, Vietnam.

Showroom: 008E Tan Da street, ward 11, district 5, Ho Chi Minh city,
Vietnam

Email: Sales@vietnha.com

Website: www.vietnha.com

Tel: 028.666.04836

Mobile: 0906.828.139